

plato

The serving Cobot



User guide

Manufacturer: Aldebaran
Original instructions: English
Document version: A02

Use Case: Plato by Aldebaran is a serving Cobot designed to assist staff by transporting objects, material, food and drinks in hospitality, retail and healthcare use cases.

Model: E02100

Contents

Safety warnings	p. 3
Overview	p. 8
What's in the box?	p. 10
Unboxing Plato	p. 11
Charging Plato	p. 12
Getting Started	p. 16
Mapping	p. 18
Poster	p. 24
Operating Plato	p. 25
Voice commands	p. 30
Taking care of Plato	p. 32
Troubleshooting checklists	p. 36
Battery Technical Specifications	p. 38
Plato Technical specifications	p. 39
More information	p. 40

Safety warnings

Read these safety warnings and instructions first



After reading, keep this user guide for future reference.

The use of Aldebaran and cobiotics is subject to Aldebaran and third-party software licence terms.

Safety notice



**IMPORTANT SAFETY INFORMATION.
READ AND MAKE SURE YOU UNDERSTAND THESE
SAFETY WARNINGS AND ALL INSTRUCTIONS
BEFORE UNPACKING AND USING THE MACHINE.**

- ▶ Warnings presented here are intended to warn you of potential harm to yourself and other people as well as damage to property. Always follow them to reduce the harm potential
- ▶ This manual also provides safety warnings, correct handling procedures, and other regulatory information for using Plato, the battery, and the battery charger
- ▶ The warnings provided in this manual do not cover all possible situations that may arise
- ▶ Safety of pedestrians and people in the surrounding area will be the first priority in all circumstances (such as when Plato does not operate properly, when Plato has tipped over, etc.)
- ▶ Always adhere to warnings regarding machine installation, maintenance, and use and keep this manual where it can always be referred to
- ▶ In the following emergencies, immediately press the Emergency button and turn off the main power switch:
 - ▷ Plato is in a hazardous situation (example: emitting smoke, is inoperable, has fallen over, etc.)
 - ▷ Plato comes close to inflicting harm on surrounding people or objects close by
 - ▷ Plato is behaving unpredictably or is operating in a manner that is inconsistent with this manual

Recycling and disposal



The machine, battery charger and battery are designed and manufactured with recyclable, high-quality materials and components. Please do not dispose of your product in everyday waste. Contact customer support.

When disposing of the machine, remove the battery from the machine, and dispose of it properly according to regulations for waste disposal in your region.

Warnings

The following symbol categories explain the level of harm or damage that can occur if warnings are not observed and Plato or related equipment is used incorrectly.

Please make sure you understand these symbols and their meanings before reading the remainder of this manual.



DANGER

Indicates a hazardous situation that, if not avoided, will result in serious injury



WARNING

Indicates a hazardous situation that, if not avoided, could result in serious injury

The following symbols indicate important information. Please make sure you understand this information before reading the remainder of this manual.



Prohibited action (not allowed)



Must not be used where exposed to water, and must not be splashed with water





Mandatory action based on instruction (must be performed)

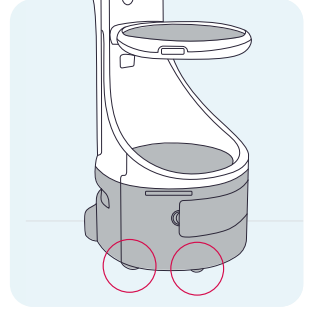
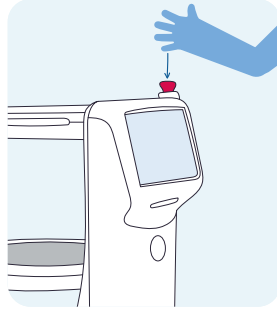

Unplug the power plug from the outlet

What to do in case of an emergency or abnormal situation?



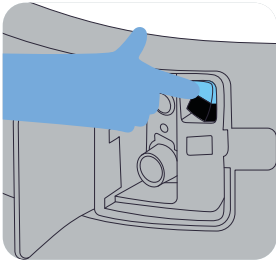

 In case of perceived danger, press the Emergency button which stops Plato immediately by braking the wheels.

 When the Emergency button is pressed, the wheels stay in braked position which prevents Plato from moving.

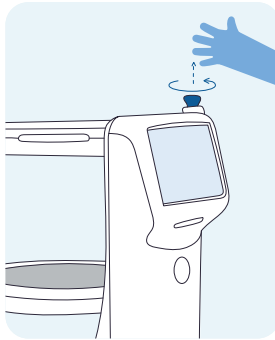
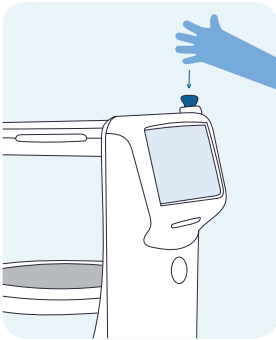

 In case of emergency, Plato can be moved manually by setting the Auto/Manual switch to the M position. The Auto/Manual switch is located behind the Charging hatch. After moving Plato to a safe position, set the Auto/Manual switch to the A position to continue Plato's tasks. *Only qualified personnel who have read and understood this manual should manually move Plato.*



 **CAUTION: PERSONAL INJURY OR PROPERTY DAMAGE RISK**
If the Emergency button is pressed, ensure that the cause of the emergency stop is resolved, and all surrounding areas are clear before releasing the Emergency button by twisting it. Then, Plato will wait for your confirmation on the screen before continuing tasks. *Only qualified personnel who have read and understood this manual should release the Emergency button.*

Warnings concerning the use of the machine

Danger



Do not use the machine in a stepped location, on an uneven floor, or on a sloping surface.

- ▶ The machine may tip over or fall and damage the machine or floor or cause injury or damage to surrounding people or property if traveling in areas with steps.
- ▶ Traveling on an uneven floor may prevent the sensors from operating normally, which may result in injury or damage to surrounding people or property.

Areas prohibited to the machine which could cause it to fall, such as slopes, steps, stairs or escalators MUST be protected with physical barriers.

The forbidden zone in the map on the screen is not a protective barrier for safety with a Performance Level (PL) according to the ISO 13849-1 and it is not intended to be used to avoid this situation.



Do not place anything decorative on the machine that may hinder its operation, such as obstructing the sensors, or the emergency button. Doing so may cause an accident.



When the machine is operating, do not let infants, children, or pets come near the machine, or place feet or hands near the bottom of the machine. Doing so may cause injury due to getting caught in the machine. Display the poster at each entrance to your establishment to inform everyone of this risk.



Plato can be used in a healthcare environment but Plato is not a medical device according to IEC/UL 60601 standards (or equivalent standards). Radio-frequency waves from electronic equipment can negatively affect the operation of other electronic equipment, causing them to malfunction, such as medical implants, causing it to malfunction.

The Health Industry Manufacturers Association recommends keeping a minimum distance of 15 cm (6 inches) between wireless devices and pacemakers to avoid interference with the pacemaker.



Be careful that dust does not adhere to the LIDAR, 3D sensors or any other sensors.

This could interfere with normal machine operation or lead to an accident.



The machine is designed to carry objects, material, food and drinks in hospitality, retail and healthcare use cases. Do not use it for any other purpose.

Caution



This appliance is not intended for use by persons (including children) with reduced physical, sensory or mental capabilities, or lack of experience and knowledge, unless they are supervised or have been given instruction concerning use of the appliance by a person responsible for their safety.



The machine is heavy. When lifting the machine from the floor, always have two people work together as a safety precaution. Not doing so may cause injury and a malfunction of the machine.







If the machine has fallen over, first press the emergency button, then turn off the main power switch on the machine before securing the area if dishes and plates are on the floor. Failure to do so may result in malfunction of the machine or damage or injury to property, individuals or the machine.













Don't leave hands or fingers on the edges of the table when you see the machine approaching. The machine can pinch. Display the poster at each entrance to your establishment to inform everyone of this risk.

Electrical warnings

Danger

-
-  **Use only the battery charger and battery supplied with the machine when recharging the machine.** Use of other battery chargers or batteries may cause fire, injury, electric shock, damage, malfunction, overheating, leakage, chemical explosion, or other damage to the battery charger.
 -  **If the machine is not operating normally (unusual sound, odour, smoke, etc.), immediately press the emergency button, to stop machine operation, turn off the main power switch, and contact customer support.**
 -  **Use the battery charger in an environment with an ambient temperature of 0 to 40°C, and relative humidity of 10 to 90%. When not using the battery charger, store in an environment with an ambient temperature of -20 to 60°C, and relative humidity of 5 to 95%.**
 -  **Do not get the battery charger or battery wet.** The battery charger and battery are all for INDOOR USE ONLY. They are not water-resistant. Do not get them wet.
-

Caution

-
-  **Do not allow liquid or semi-liquid substance or any foreign objects to touch the charging terminals or external connection terminals of the battery charger or battery, or to otherwise enter the machine.** Doing so may result in fire, injury, electric shock, damage, malfunction, overheating, leakage, chemical explosion, or other damage to the machine, battery charger or battery.
 -  **Do not insert any objects in the machine.** Doing so may cause fire, injury, electric shock, damage, malfunction, overheating, leakage, chemical explosion, or other damage to the machine, battery charger or battery.
 -  **If fluid leaks, do not touch with bare hands.** If fluid enters your eyes, wash well with clean water, and immediately consult a doctor. If fluid gets on your skin or clothes, wash well with water.
 -  **The battery must be removed before cleaning or maintaining the appliance.**
 -  **The battery charger may get hot, so take care when handling during or immediately after charging.**
 -  **Do not use a power cable other than the one supplied with the machine. Also, only use the power cable in the country indicated on the label affixed to it.** Otherwise, it may cause fire, injury, electric shock, damage, malfunction, overheating, leakage, chemical explosion, or other damage to the machine, battery charger or battery.
 -  **Do not use the battery charger or power cable if damaged.** Doing so may cause fire, injury, electric shock, damage, malfunction, overheating, leakage, chemical explosion, or other damage to the machine, battery charger or battery. **If the supply cord is damaged, it must be replaced by the manufacturer, a service agent or similarly qualified persons in order to avoid a hazard.**
 -  **Do not remove the battery when the machine is powered on.** Make sure the machine is turned off and disconnected from the supply mains before removing the battery.
 -  **Always unplug the battery charger from the outlet if not using it for a long time or when carrying out maintenance on it.** Failure to do so may cause fire, injury, electric shock, damage, malfunction, overheating, leakage, chemical explosion, or other damage to the machine, battery charger or battery.
 -  **If the battery charger is not operating normally, takes a longer time to recharge than normal, or if it produces sparks, smoke, odour, etc., immediately unplug it from the outlet, and contact customer support.** Failure to do so may cause fire, injury, electric shock, damage, malfunction, overheating, leakage, chemical explosion, or other damage to the machine, battery charger or battery.
-

Overview

Plato helps you deliver food or drinks to your customers and collect their dishes.
Enjoy the company of your new friend!



Headset
(option)

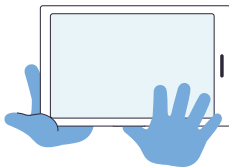

Tablet

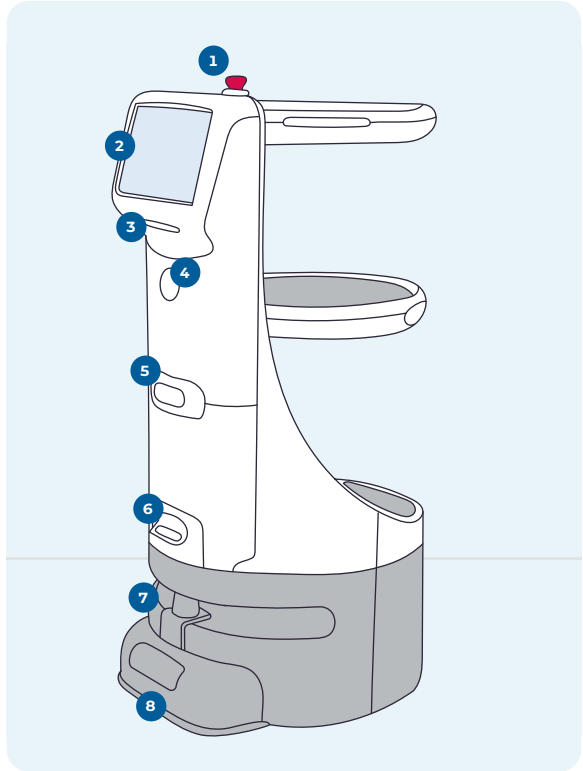

- 1. Emergency button
- 2. Display
- 3. 5. & 6.
3D Sensors 1, 2 & 3
- 4. Speaker
- 5. Lidar
- 6. Safety bumper
- 7. Top shelf
- 8. 11. & 18.
Lights
- 12. Top shelf button
- 13. Middle shelf
- 14. Pause/Resume button
- 15. On/Off button
- 16. Product label
- 17. Bottom shelf
- 19. Battery hatch
- 20. Charging hatch

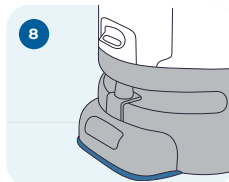

Safety bumper



The safety bumper absorbs impact and stops Plato.
► When the bumper meets an obstacle, Plato immediately brakes to a stop position
► If there are no obstacles, Plato resumes its Mission after 2 seconds

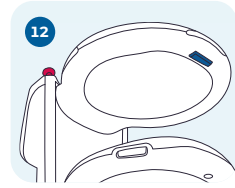

Top shelf button

Tell Plato to skip the ongoing task or the whole Mission



Pause/Resume buttons

Pause or resume Plato's ongoing task

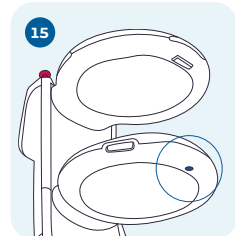

On/Off button

Press to turn Plato on
Hold to turn Plato off

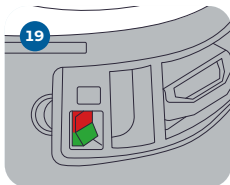

Main switch

Behind Battery hatch
Turn Plato's power supply on or off

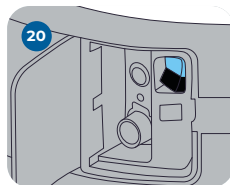

Auto/Manual switch

Behind Charging hatch
Put Plato in Auto or Manual mode

What's in the box?

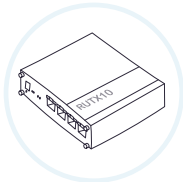

Router

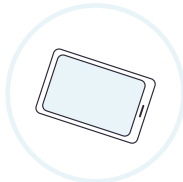

Tablet



Documentation:

- User Guide
- Routers and Accessories Guides
- Residual risks poster
- Certification Leaflet

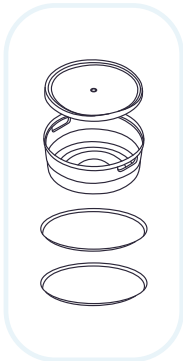

Delivery and collecting accessories:
- 2 Round trays
- 1 Collecting tub and cover

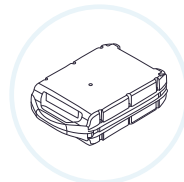
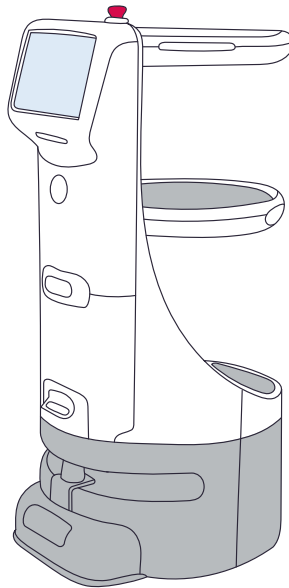

Battery
By default (a spare battery may be optional)

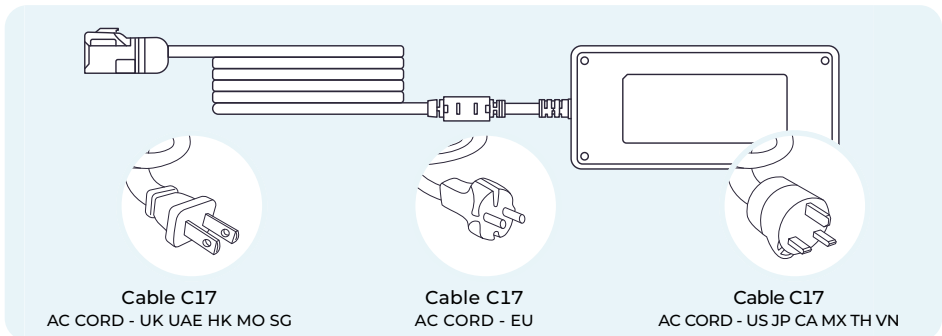

Cable C17
AC CORD - UK UAE HK MO SG

Cable C17
AC CORD - EU

Cable C17
AC CORD - US JP CA MX TH VN

Battery Charger with AC cord
Depending on the standards in force in the destination country

Unboxing Plato

Follow the instructions on Plato's box.

1.

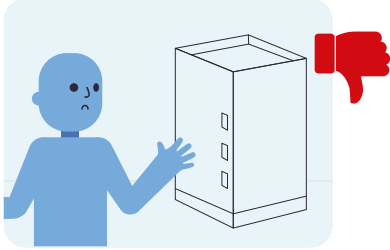

2.

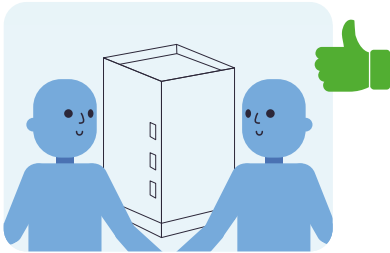
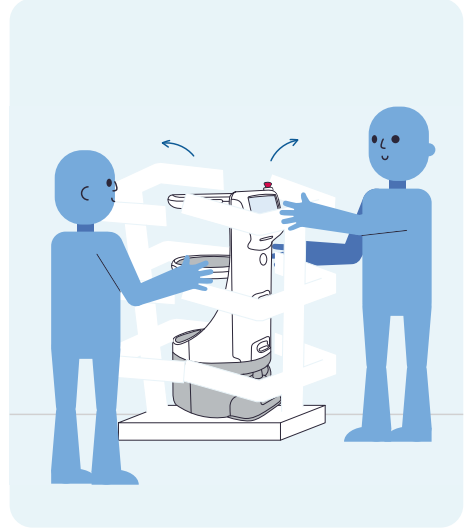

3.



4.



5.



6.

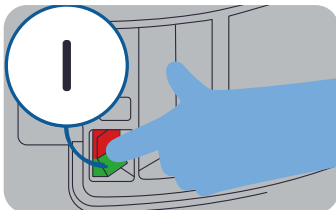

Charging Plato

1.

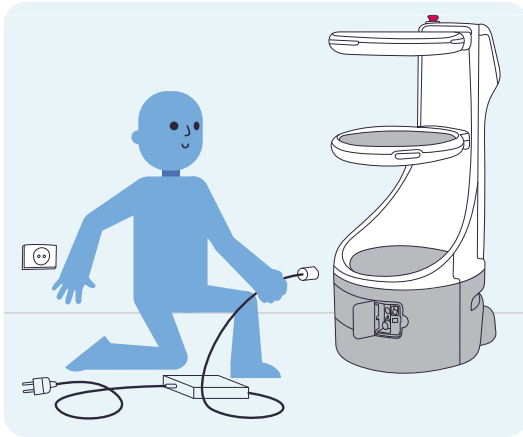

2.

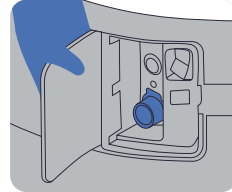

3.

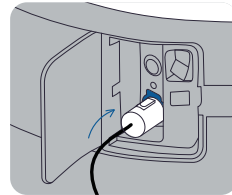

4.

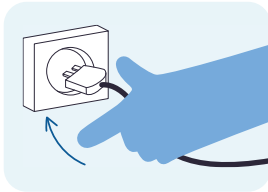

5.

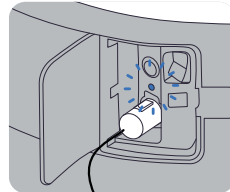

- Plato is charging
- Plato is fully charged



Fully charge Plato before first use and at the end of each shift.



Fully charge Plato before first use.

It is recommended to maintain the battery level between 30% and 80% for extended product life.

Even when not in use, charge the battery every 5 months if the battery is stored at 30% and every 20 months if the battery is stored at 100%.

Battery life: the battery guarantees 12 hours operation for Plato depending on use.

Charging time: 3 hours 30 minutes (0>80%)
7 hours 30 minutes (0>100%) for 240 W.

Shutdown: Plato turns off when the battery level is $\leq 6\%$.

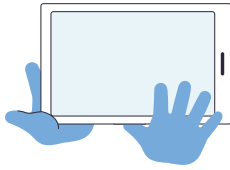

See the manual included in the Tablet box to learn how to charge it.



- ▶ The Plato's battery level is indicated in the top left corner of the Display
- ▶ Plato warns you in the Headset if the battery level is too low

Removing the battery from Plato



DO NOT remove the battery if Plato is turned on.
Make sure Plato is turned off and unplugged
before removing the battery.

1.

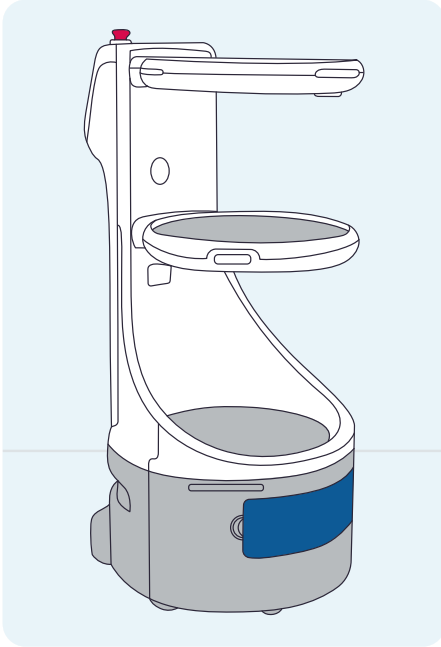

2.

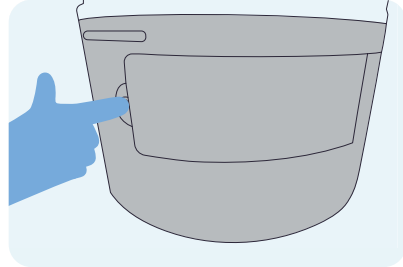

3.

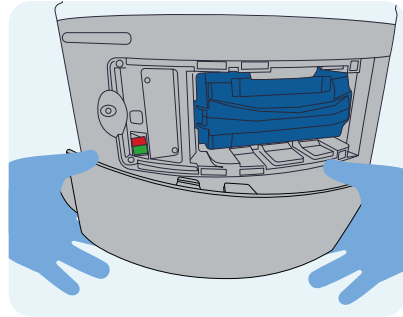

4.



5.

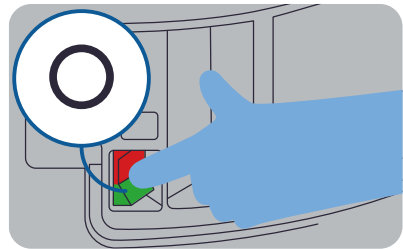

Understanding Plato's battery's level

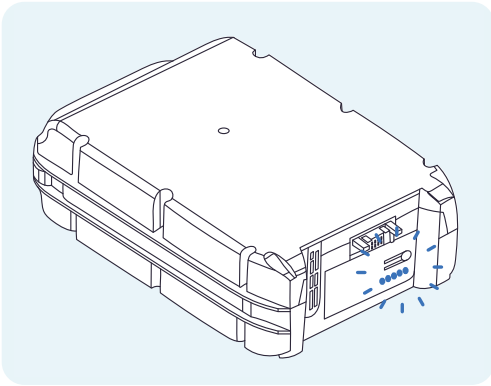

Push the State of charge (SOC) button to display the level of charge of Plato's battery.

● ● ● ● ●	$0\% \leq \text{SOC} \leq 10\%$
● ● ● ● ●	$10\% \leq \text{SOC} \leq 30\%$
● ● ● ● ●	$30\% \leq \text{SOC} \leq 50\%$
● ● ● ● ●	$50\% \leq \text{SOC} \leq 70\%$
● ● ● ● ●	$70\% \leq \text{SOC} \leq 100\%$

Getting Started

Turning Plato On

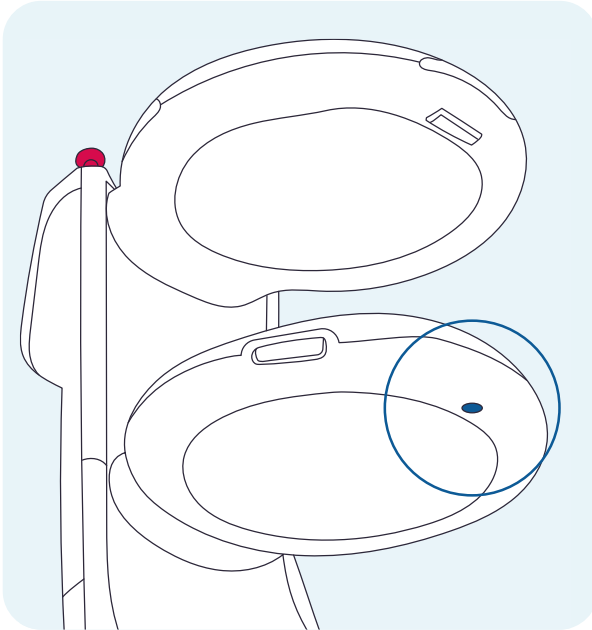

Press the
On/Off Button
for 2 seconds

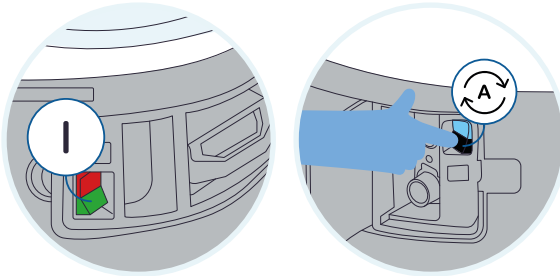

Check that the Main switch is in the I position and the Auto/Manual switch is in the A position.

Setting up Plato for the first time



Follow the instructions on Plato's display and the Tablet to configure Plato.

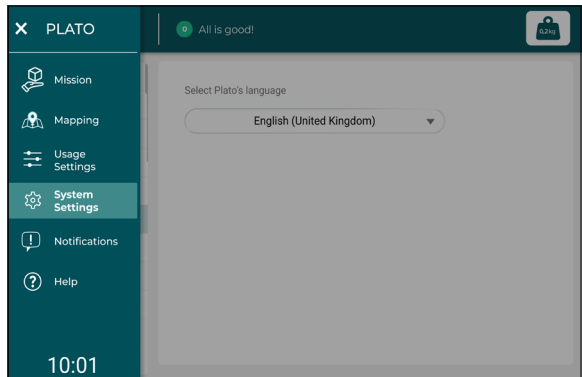

Change the Tablet's language with the Android settings by adding the new language on the top of the list.



Refer to the additional Router's guide to check how to setup 4G router and/or WIFI router.

Mapping

To have Plato ready to navigate in your space, you first need to **map** your place and **annotate** it.

Mapping with Plato is easy. Just follow these recommendations!

Preparing your room

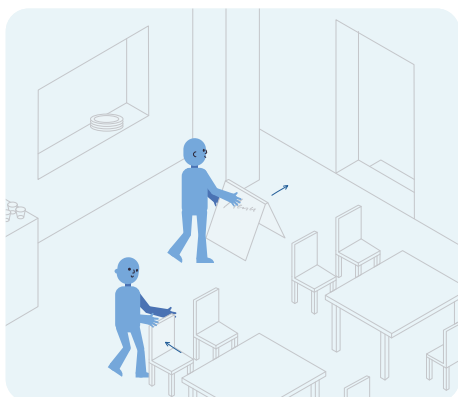

1. Set the room as for a regular service

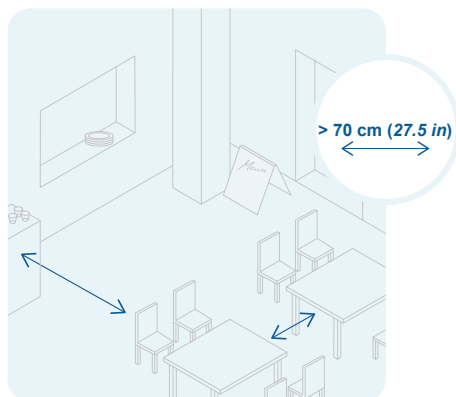

2. Make sure that the Plato path is at least **70 cm (27.5 in)**



3. Make sure nothing and nobody obstructs the path



Turn on all the lights in the room. Prepare the room as for the service and move the chairs back from the tables.

Mapping your room

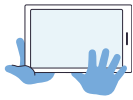

1. On the Tablet, open the menu and go to Mapping

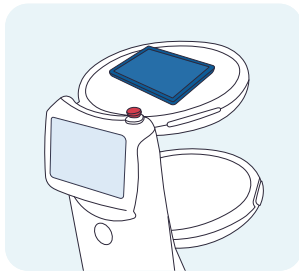

2. Put the Tablet on the Top shelf and follow the instructions

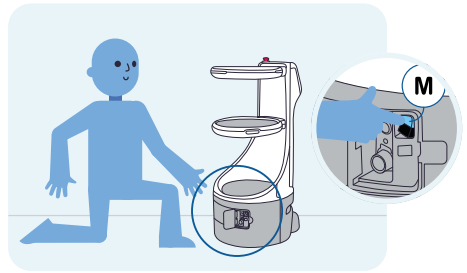

3. Set the Auto/Manual switch to the M position



4. Then, on the Tablet click on Start mapping



5. Hold the Top Shelf like a steering wheel and push Plato forward

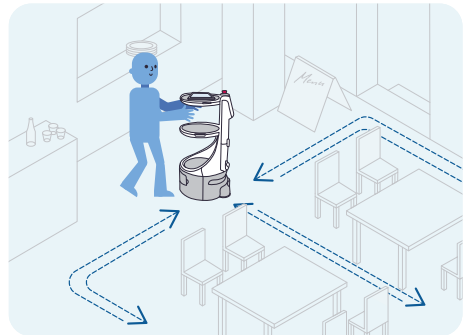

6. Move Plato **back and forth** along all the paths Plato must go



7. Move Plato up to **1 cm (0.4 in)** from walls and obstacles

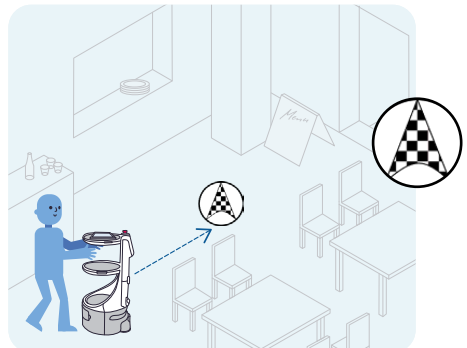

8. Then return to the starting point to complete the mapping

9. Finally, click on the Finish and save button



CHECK THE MAPPING RESULT BEFORE SAVING

Move Plato over the paths until all paths are white and clean on the map.

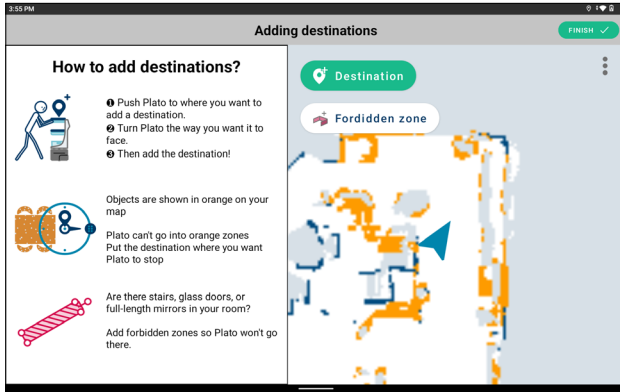

Adding annotations

Create and edit a Destination for each table and useful points of the service where Plato should go.

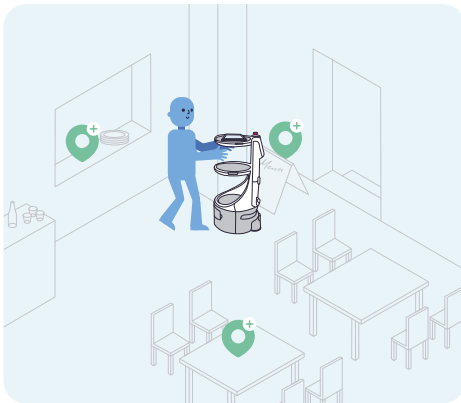

1. Move Plato to a strategic position

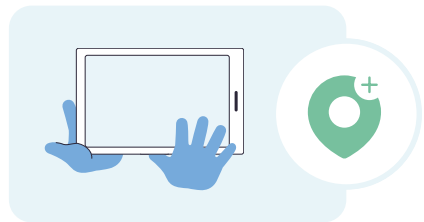

2. Then, on the Tablet click on the Add Destination button



Do not place Destinations in the orange Obstacle areas, Plato will not go there!

3. Choose Plato's orientations for a Destination

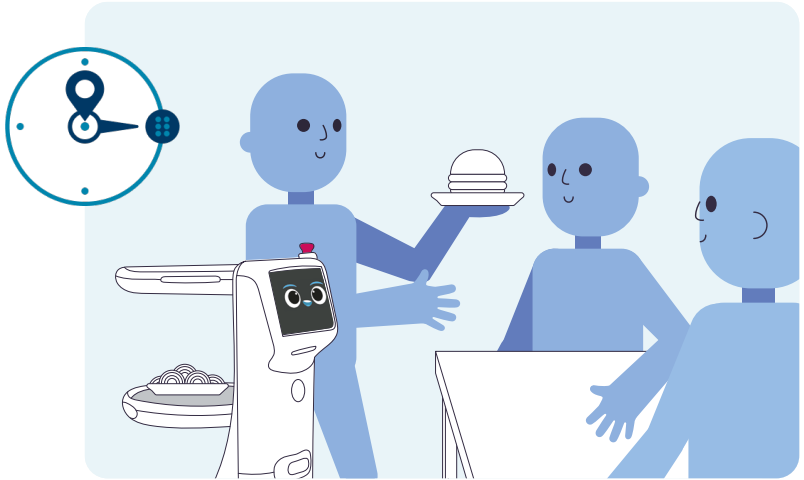

a. Plato's screen facing customers

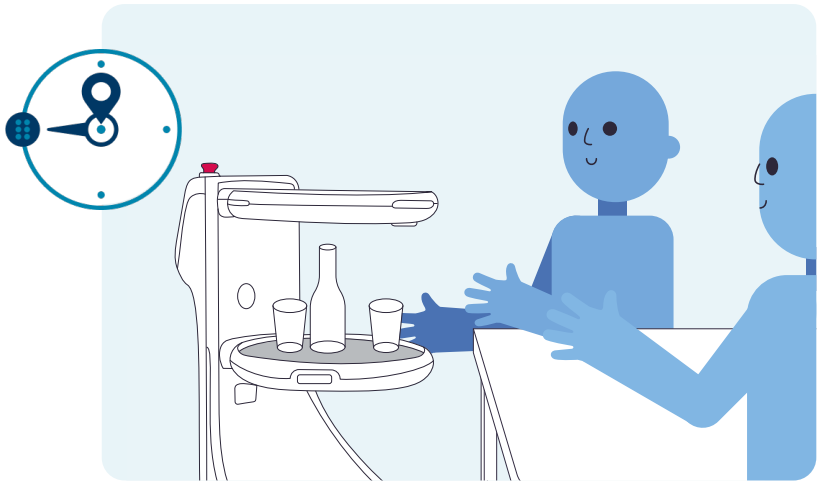

b. Shelves facing customers



- ▶ Choose helpful destinations as relay area
- ▶ Plato can assist kitchen staff and waiters, by servicing areas where waiters pick up or drop off dishes

Creating Forbidden zone

Edit and create Forbidden Zones where Plato can not go (shown in red on the map).

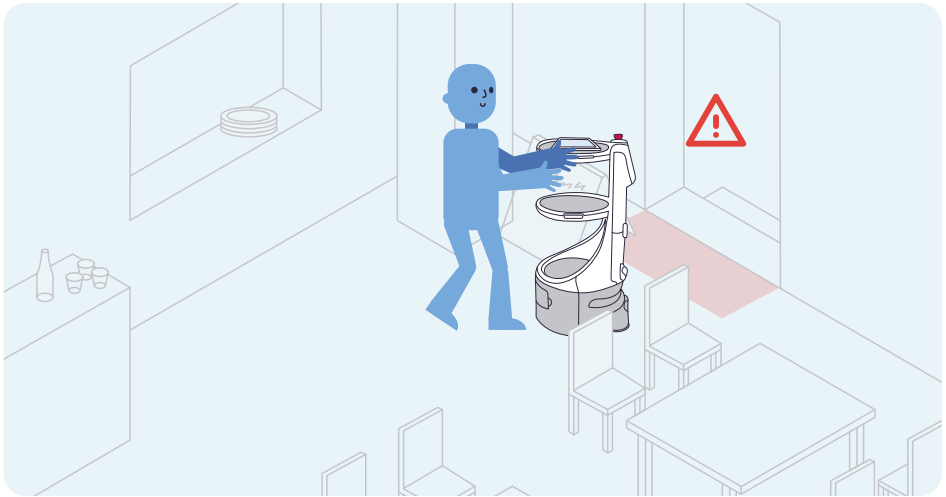

1. Move Plato past all obstacles, glass doors, mirrors, escalators and stairs

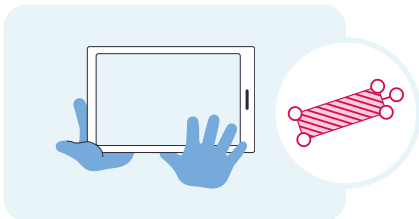

2. Add a forbidden zone for each location with the Add forbidden zone button

3. Resize and rotate the forbidden areas on the map to fit



Prepare the room for the service and anticipate the movement of furniture by adding a Forbidden Zone around furniture that may be moved.



Areas that could cause Plato to fall, such as slops, steps, stairs or escalators, MUST be protected by physical barriers. Please refer to the safety instructions in this guide.

Testing a map with a Mission

Once the mapping is complete, test the destinations with a training mission.

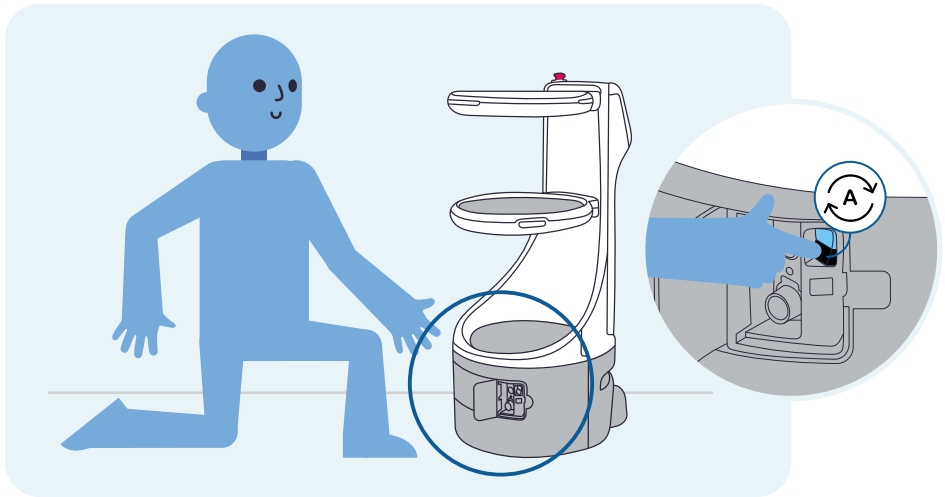

1. Set the Auto/Manual switch to the A position

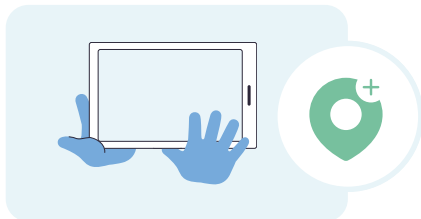

2. On the Tablet, add all the Destinations to a mission

3. Press Start for Plato to begin the Mission



► **Check Plato's behaviour with a test map and a few destinations to identify any areas where Plato might have difficulty finding his way.**

► **You can create several maps for different room layouts, environments or services (for example, self-service buffet, table service or conference room).**

► **At the beginning of your service, activate the appropriate map saved according to the room configuration.**

When you have completed the room mapping and added Destinations, Plato is ready to help you!

Poster

Display the poster at each entrance to your establishment so everyone knows Plato works here and is aware of the residual risks.

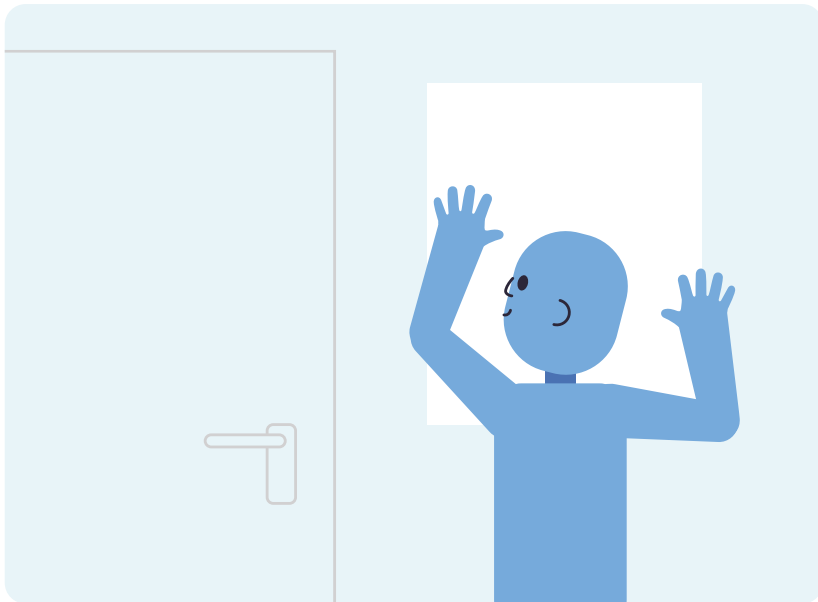

Operating Plato



- ▶ Each shelf, including accessories, has a maximum load of 10 kg.
- ▶ Plato is not compliant with the Food Contact Directive. Do not place unprotected food (pieces of bread, fruit with edible skin, etc.) directly on Plato. To carry unprotected food, please use the appropriate food contact accessories.
- ▶ A collision or any other emergency stop situation may cause loads to fall from Plato, which could cause serious injury. Restaurant staff must ensure the stability of dishes and any other items loaded on shelves before starting a Delivery, Collecting, Birthday or Cruise task.

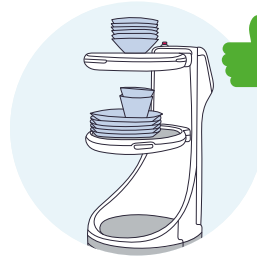
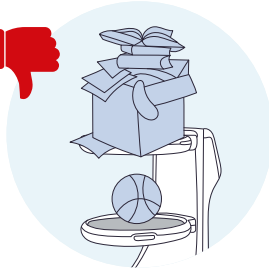

- ▶ Aldebaran is not responsible in the event of injuries following such an incident. Aldebaran provides accessories for various types of dishes and glasses to help ensure the stability of loads on Plato. Please contact your distributor for more information.

Customising Plato with the Settings

On Plato's display or the Tablet, go to the Settings menu.



Press 3 seconds on the Advanced settings button to access Advanced settings.

Creating a Service Mission

Plato can deliver something or someone with a Service Mission.

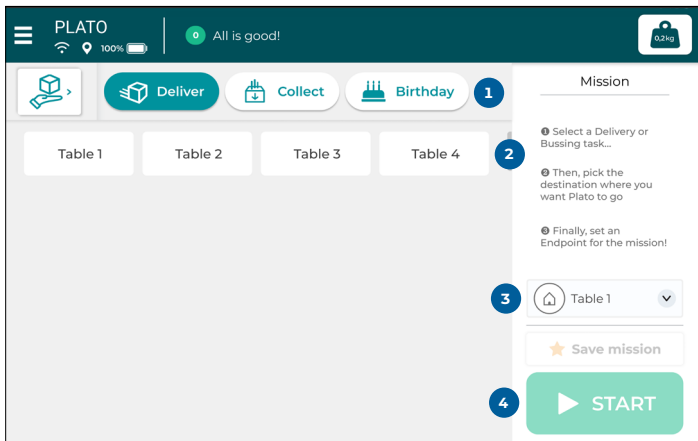

1. On Plato's display or the Tablet, select a Delivery, Collecting or Birthday task
2. Select a Destination
3. Select an Endpoint
4. Press Start

Delivery task

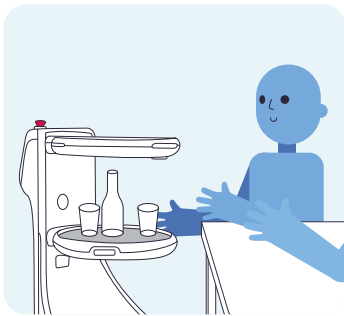

Arriving at the destination, Plato says something and waits for the dishes to be served.

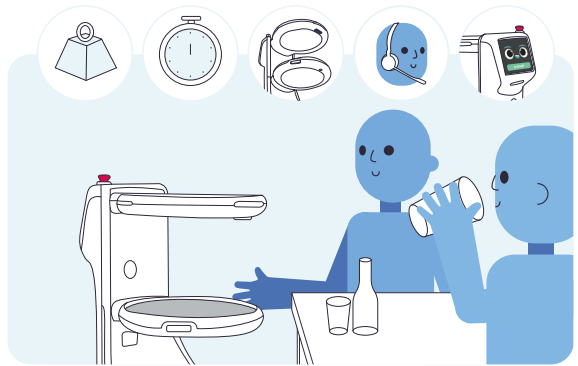

Plato leaves either when the shelves have been emptied, the timer has expired or someone presses the Done button or skips the task.

Collecting task

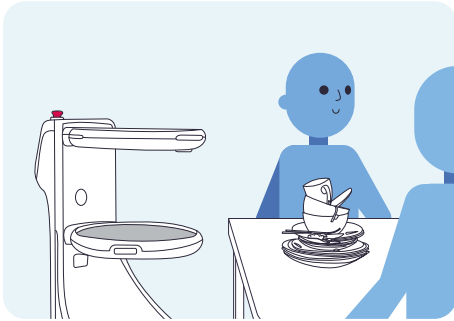

Arriving at the destination, Plato says to clear the table.

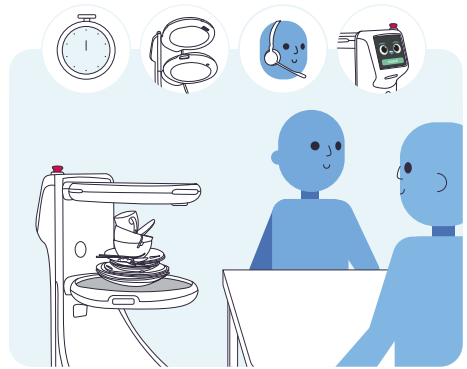

Plato leaves when the timer expires or someone presses the Done button, or skips the task.

Birthday task

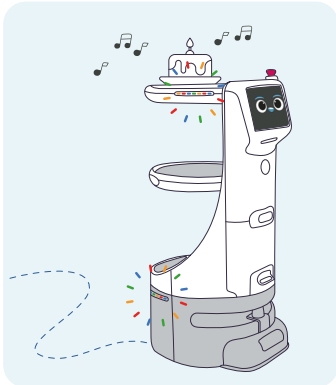

Plato goes to the destination singing a birthday song and turns on multicoloured lights.

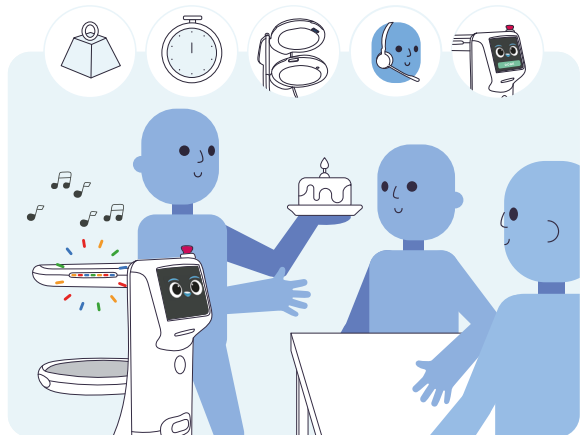

Plato leaves as for a Delivery task.



**The end-of-task triggers (weight, timer...) are configurable in the Settings.
At the beginning of a service and everytime an accessory is changed, you should press the Tare all shelves button on Plato's display.**

Creating a Cruise Mission

Plato can loop around several points with a Cruise Mission.

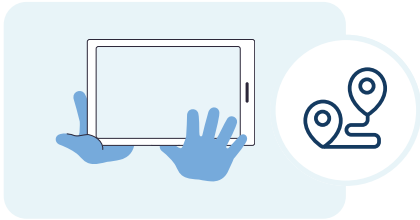

- 1.** On Plato's display or the Tablet, go to the Mission configuration screen:
 - a.** Click on the Switching mode button and select Cruise
 - b.** Select a list of Destinations
 - c.** Save the mission for future use
- 2.** Press Start when Plato is ready to cruise

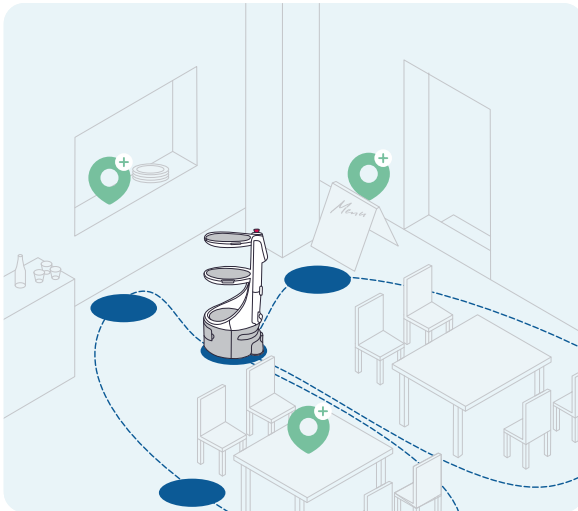

Pause Plato to edit or complete an ongoing mission

Interacting with Plato

You can interact with Plato in many ways during the missions.









Managing Plato during Missions

	SET AND START A MISSION	PAUSE AND RESUME A TASK	SKIP A TASK	CANCEL/END A MISSION
Plato's display	✓	✓	✓	✓
Tablet	✓	✓	✓	✓
Headset	✓	✓	✓	✓
Pause/Resume Buttons		✓		
Top Shelf Button			✓	✓



When Plato is navigating, you can also pause a task by double clicking with two fingers on the screen.

Understanding Plato's lights

-  Static Blue → Waiting for order
-  Static White → Navigating
-  Static Green → Validation Task
-  Static Orange → Blocked
-  Static Red → Critical error
-  Blue progress bar → Waiting at Destination with timer
-  Pulsing White → Turning on/off
-  Pulsing blue → Pausing mission



Listening to Plato's feedback sentences

Plato can say Feedback sentences in various situations, such as when arriving at a table for delivery.

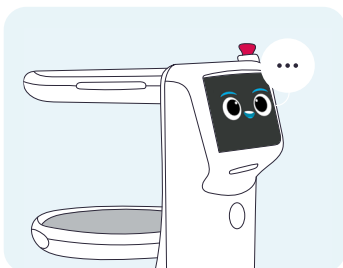

You can select which Feedback sentences Plato will say in the **Settings**.

Voice commands

You can give commands and hear feedback from Plato with the supplied **Headset**.



Refer to the supplied **Headset** documentation for full utilisation instructions.

Setting up the headset

1. Go to Plato's **Settings**
2. Press **Headset pairing**, then follow the instructions



We strongly recommend using your working language when talking to Plato to get the best results. If needed, you can change Plato's language in the **Settings**.

Giving voice commands to Plato



1. Put on your **Headset** with the microphone in front of your mouth
2. Choose the task you want Plato to perform
3. Speak normally and avoid pausing verbally between "Plato" and the command



TIPS 'N TRICKS FROM PLATO

Follow these tips for the most efficient experience

Name your **Destinations** so they are easy to pronounce

- ▶ Don't use articles such as the, a or an
- ▶ Don't name **Destinations** with a single letter
- ▶ Don't use special characters or emojis

DO	DON'T
Kitchen	X Æ A-Xii
Table 1	The table 1
P1	P 1

The list of voice commands

SERVE A TABLE	“Plato serve (slowly) <destination>” / “Plato go to <destination> (slowly)”
CLEAR A TABLE	“Plato clear <destination>”
BIRTHDAY MODE	“Plato birthday at <destination>”
PAUSE PLATO	“Plato pause mode” / “Plato pause yourself”
RESUME FROM PAUSE	“Plato resume your task” / “Plato continue”
SKIP WAITING TIME AT THE TABLE	“Plato move on”
CANCEL ALL TASKS	“Plato stop your mission”
BE NOTIFIED ABOUT STATUS	“Plato what’s up”

Taking care of Plato



Don't lift, bump, push, or climb on Plato



Don't stack things on Plato and don't exceed the maximum load

Don't remove any screws or open any covers except the Battery hatch and the Charging hatch

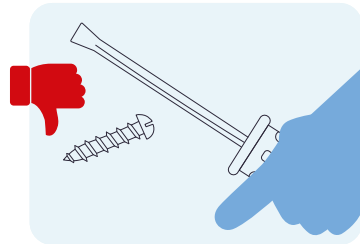

Moving Plato manually

1.

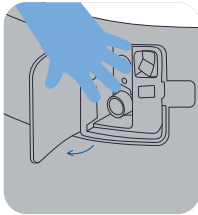

Open the Charging hatch

2.

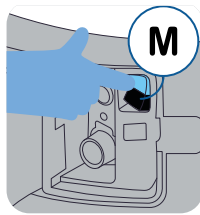

Set the Auto/Manual switch to the M position

3.



Hold the top shelf and move Plato by pushing it forward. You can use the top shelf to direct Plato



When you're done, set the Auto/Manual switch back to the A position so Plato can move safely on its own.



Regulatory authorities require the Auto/Manual switch to be tested once a month.

Turning Plato off

Hold the On/Off button for 3 seconds

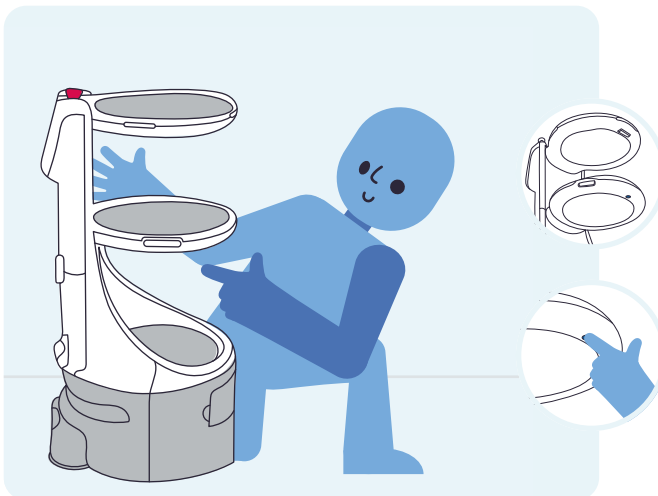

Don't flip the Main switch while Plato is On.



Make sure Plato is turned off and unplugged.



- ▶ 2 people are needed to lay down Plato
- ▶ Empty Plato and remove all accessories from its shelves
- ▶ Place a piece of soft material on the floor such as a towel or a rug

Wheels

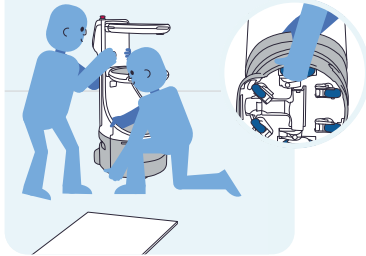

1. Hold Plato firmly

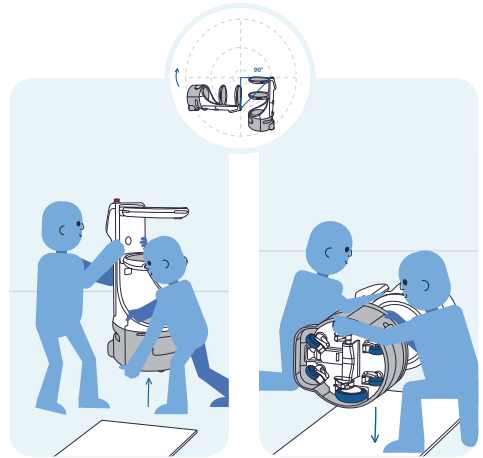

2. Lift Plato

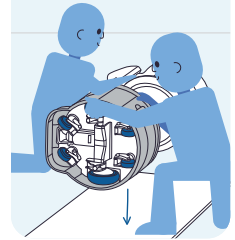

3. Tilt Plato and gently lay it down on the piece of soft material

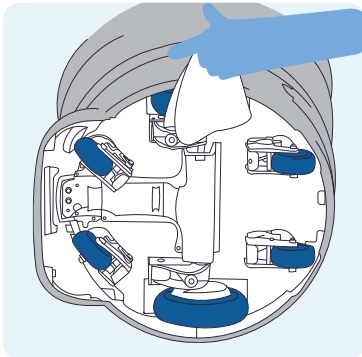

4. Remove any debris from the wheels and base



- ▶ Be careful not to pinch your fingers
- ▶ To hold Plato by the base, place one hand on the wheel instead of the base cover because covers can be sharp

Sensors

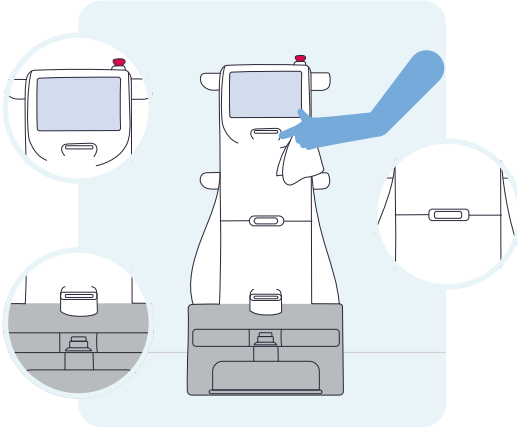

Clean Plato's body and sensors with a **soft dry cloth**.

Plato can be cleaned with:

- ▶ Alcohol based detergent (Ethanol purity 50% - 75%)
- ▶ Sodium hypochlorite Sanitizer
- ▶ Alkaline electrolysed water
- ▶ Neutral detergent
- ▶ IPA (Iso-propyl-alcohol)

Using the Emergency button

Push it to stop Plato in case of emergency

For example when:

- ▶ Plato has tipped over
- ▶ Plato does not operate properly

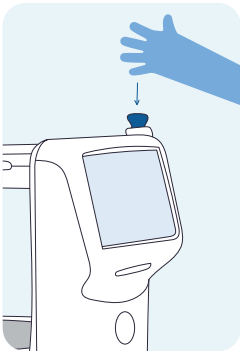

When all is safe



1. Release the Emergency Button by twisting it



2. Follow the instructions on Plato's display



Regulatory authorities require the emergency stop function to be tested once a month.

Troubleshooting checklists

Use these checklists to troubleshoot Plato.

Plato doesn't work as expected

Check on the router that:

- ❑ The WiFi antennas are inserted in the WiFi ports
- ❑ The Power adapter is plugged in to a Power socket
The PWR light is on
- ❑ The 2.4 light is on
- ❑ The WAN port is connected to the internet
The WAN green light is on
You have access to the Internet when you connect another device to the router network

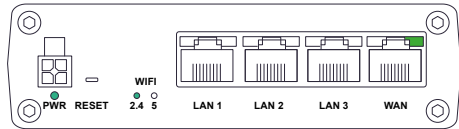

RUTX10

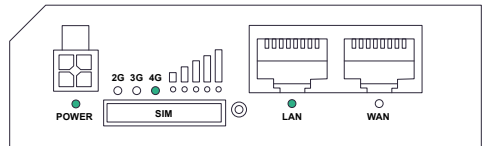

RUT240

On Plato, check that

- ❑ The Main Switch is in the I position
- ❑ The Emergency button is released
- ❑ The Auto/Manual button is in the A position
- ❑ Plato is On
- ❑ The Plato application is running on Plato's display
- ❑ Plato is connected to the Router
Look under the Router to find WiFi network information

On the Tablet, check that:

- ❑ The Tablet is On
- ❑ The Plato application is running
- ❑ The Tablet is connected to the Router

Plato can't move

Plato can't access its Destination

- Make sure there are no obstacles around Plato preventing it from reaching its Destination
- Make sure the Plato's Destination is not in a Forbidden zone in the Annotation screen.
- Edit the Destination to make sure it's not too close to obstacles.
- Check that the Plato's Destination is not located in an obstacle in the Annotation screen
- Make sure the Plato's wheels and Plato's sensors are clean
- Make sure Plato's battery has enough charge

Plato can't localize itself

- Gently move or turn Plato in the environment to give Plato more visual references in space so Plato can find where it is.

The Emergency button has been pressed

- Check that everything is safe, then release Plato's Emergency button

Plato is overloaded

- Remove some items from Plato's shelves

Plato isn't connected to the WiFi

- Please check your Router's connection. Refer to the additional Router's guide to check how to setup the 4G router and/or WIFI router

Plato is in Manual mode

- Set the Auto/Manual switch to the A position

Plato is in a Forbidden zone

- Set the Auto/Manual switch to the M position, then push Plato outside the Forbidden zone and set the Auto/Manual switch to the A position

Plato does not turn on

- Plug in the charger to reactivate the battery and turn Plato back on



ADVANCED TROUBLESHOOTING
Please check Aldebaran.com and contact your retailer.

Battery Technical specifications

BATTERY	Average charging time	The battery guarantees 12 hours of autonomy for Plato depending on use. Charging time for 240 W: 3 hours 30 minutes (0>80%) 7 hours 30 minutes (0>100%)
	Average operation hours	The battery guarantees 12 hours of autonomy for Plato depending on use.
	Charging voltage	30 VDC
	Dimensions	284 × 193 × 82 mm (including handle) (11.2 × 7.6 × 3.23 in)
	Energy/Rated capacity	38.4 Ah
	Energy/Nominal energy	995 Wh
	Model	Varta, 7S12P
	Type	Ion-Lithium
	Guarantee	3 years or 1000 cycles
POWER SUPPLY	Weight	4.95 kg (10.4 lb)
	Cable length	1850 mm (72.8 in)
	Dimensions	194.9 × 89.9 × 42.8 mm (7.67 × 3.54 × 1.68 in)
	Input frequency	50 ~ 60 Hz
	Input voltage	100 ~ 250 VAC
	Output power	235.2 W
	Guarantee	3 years or 1000 cycles and 30,000 hours minimum.
Weight	1.2 kg (2.65 lb)	

Plato Technical specifications

3D SENSORS 1, 2 & 3	Laser class 1	
DIMENSIONS	Height	1113 mm (43.8 in)
	Length	545 mm (21.4 in)
	Width	500 mm (19.68 in)
DISPLAY	Touchscreen	10.1 pouces (10.1 in) 1280 × 800 resolution
NAVIGATION	Gap crossing	10 mm (0.39 in) max
	Mapping area	300 m ² (3 220 square ft ²)
	Robot path width	70cm (27,6 in)
	Max speed	2.6 km/h (0.7 m/s) 1.61 mph (2.36 feet per sec)
	Obstacle step	No step allowed
	Slope	No (0° +/- 0.5°)
NOISE	Max environment noise for voice commands	75 dB
RADIO MODULE	Protocols	802.11n/ac 2X2 MU-MIMO 2.4GHz/5GHz WiFi Bluetooth/LE 5.x
ROBOT POWER	Input current	8 A
	Input voltage	30 V DC
STORAGE CONDITIONS	Storage relative humidity	90% max non-condensing
	Storage temperature	-10 °C ~ 60 °C (14 °F to 140 °F)
WEIGHT	Payload	Top Shelf: 10 kg (22.05 lb) Middle shelf: 10 kg (22.05 lb) Bottom shelf: 20 kg (44.1 lb) Total: 30 kg max (66.2 lb)
	Robot empty weight including battery	53 kg (117 lbs)
WORKING ENVIRONMENT	Operating humidity	20% ~ 85% non-condensing
	IP Ingress protection against dust and wet	Class IP42
	operating temperature	5 °C ~ 40 °C (41 °F ~ 104 °F)

FIREWALL CONFIGURATION	TCP	80, 433, 8883
	UDP	123
	DNS	*-ats.iot.\$amazonaws.com *s3.amazonaws.com

More information



Find all the documentation and tutorial videos online.

Aldebaran reserves the right to make any changes to the Product and its documentation without prior notice or correction to the User. The present documentation in its latest version is downloadable for free at the following address <https://www.aldebaran.com/plato/documentation/index.html>

The full text of the EU declaration of conformity is available at the following internet address: <https://www.aldebaran.com/en/conformity>